

RING S
10276

RING M
10277

RING L
10278

THIS PRODUCT CONTAINS A LIGHT SOURCE OF ENERGY EFFICIENCY CLASS: F (10276, 10277, 10278)

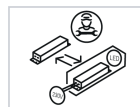
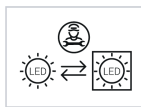

1

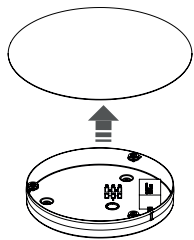

2

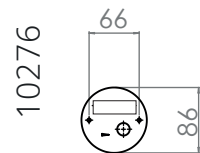
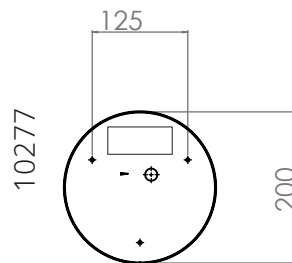
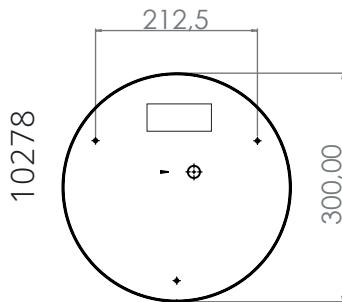

3

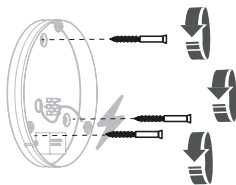

4

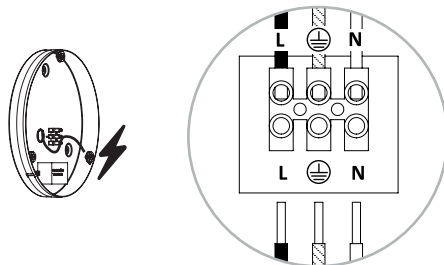

5

