

RING S  
10280

RING M  
10281

RING L  
10282

THIS PRODUCT CONTAINS A LIGHT SOURCE OF ENERGY EFFICIENCY CLASS: F (10280, 10281, 10282)

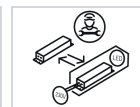
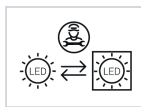

1

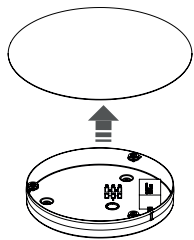

2

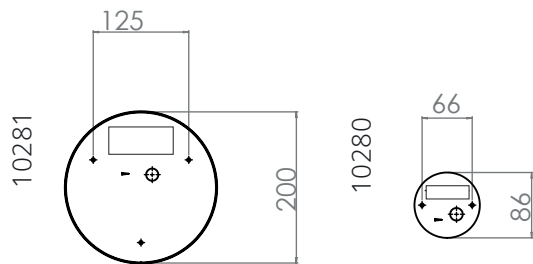
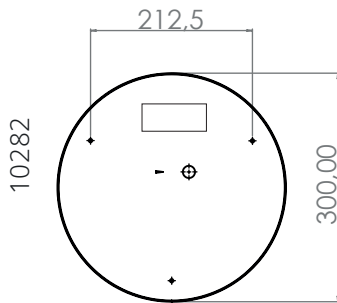

3

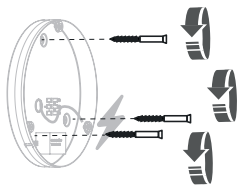

4

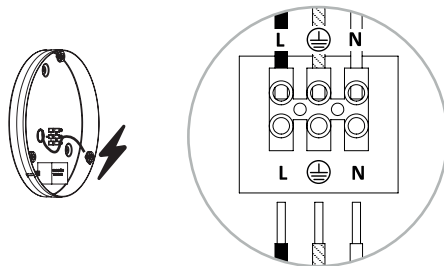

5

