

RING S

10317 | 10316
10315



RING M

10350 | 10347
10352



RING L

10351 | 10348
10353

THIS PRODUCT CONTAINS A LIGHT SOURCE OF ENERGY EFFICIENCY CLASS: F (10317, 10316, 10315, 10350, 10347, 10352, 10351, 10348, 10348)

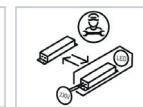
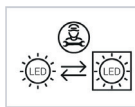

1

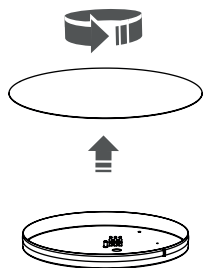

2

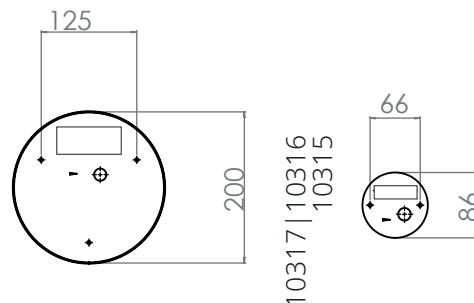
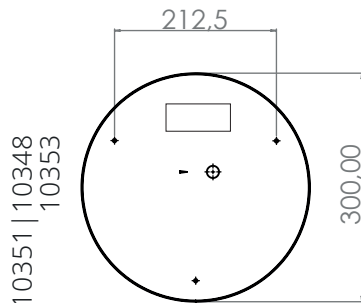

3

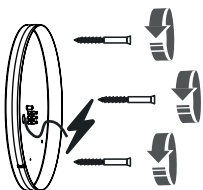

4

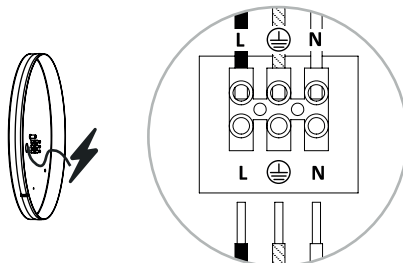

5

