

GLOBO

LIGHTING

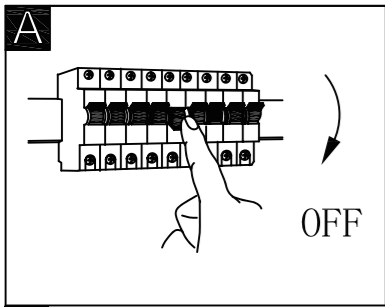





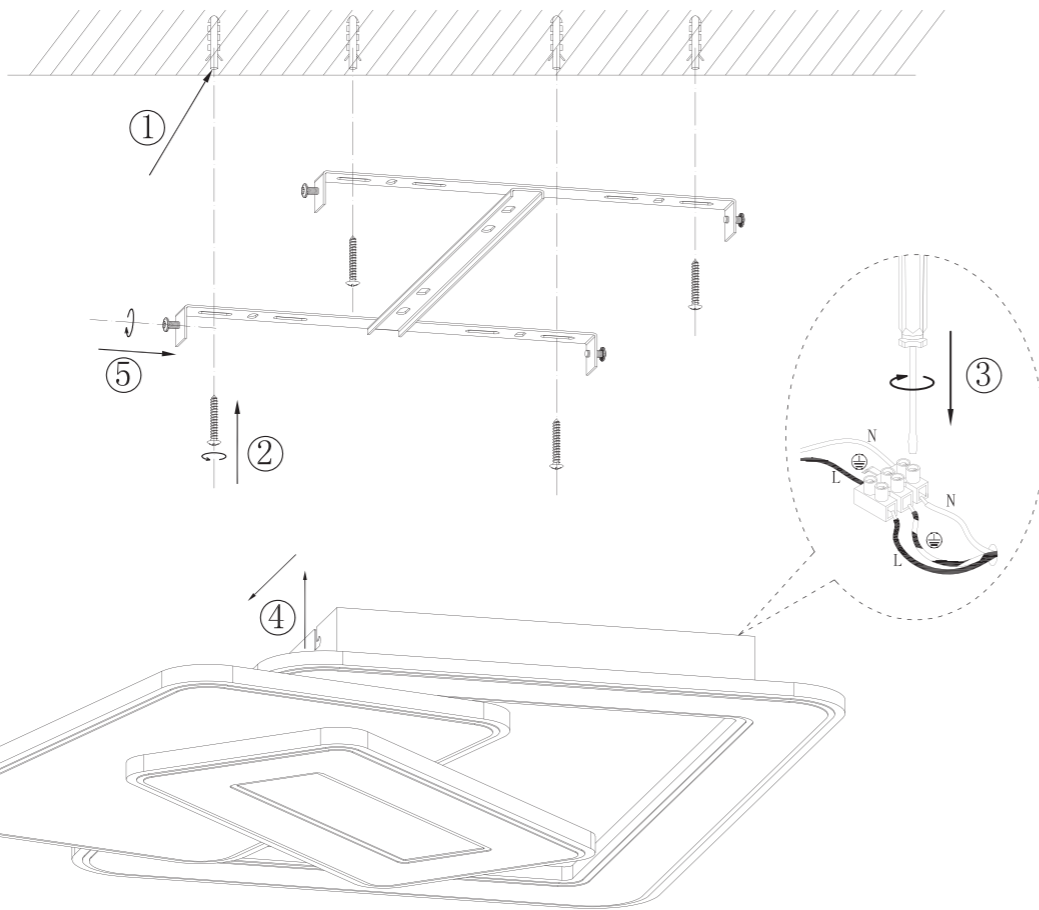

48548SH

smart voice control 





B



-  3 LIGHT STEPS 3000 K
-  APP
-  3000 K - 6500 K
-  dimmable
-  incl.
-  memory function
-  many steps
-  night light

smart APP control

free APP

compatible with Alexa  Powered By 
 compatible with Google Assistant  Intelligence Engine

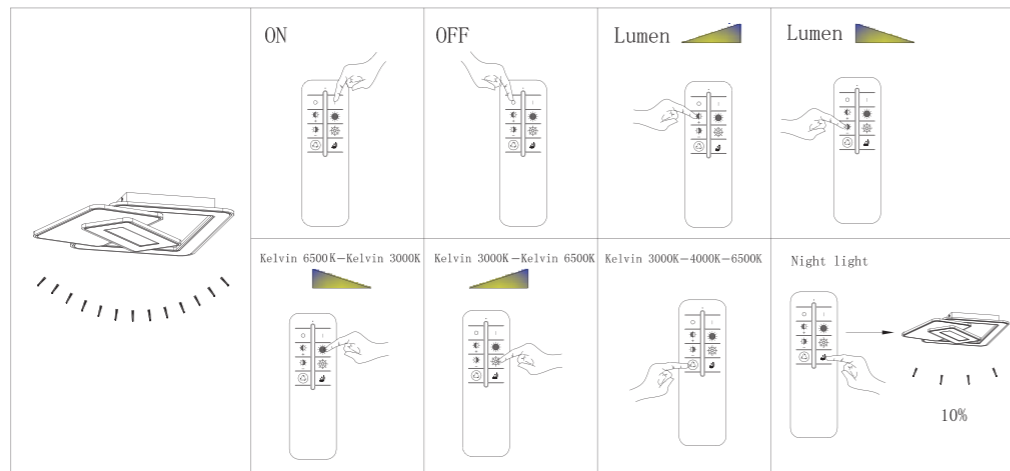
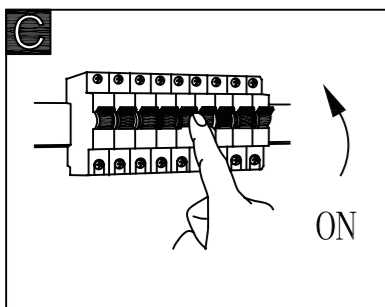

Download Tuya App:



Get latest manual:



Functional Video:



Tuya App - Pairing Process

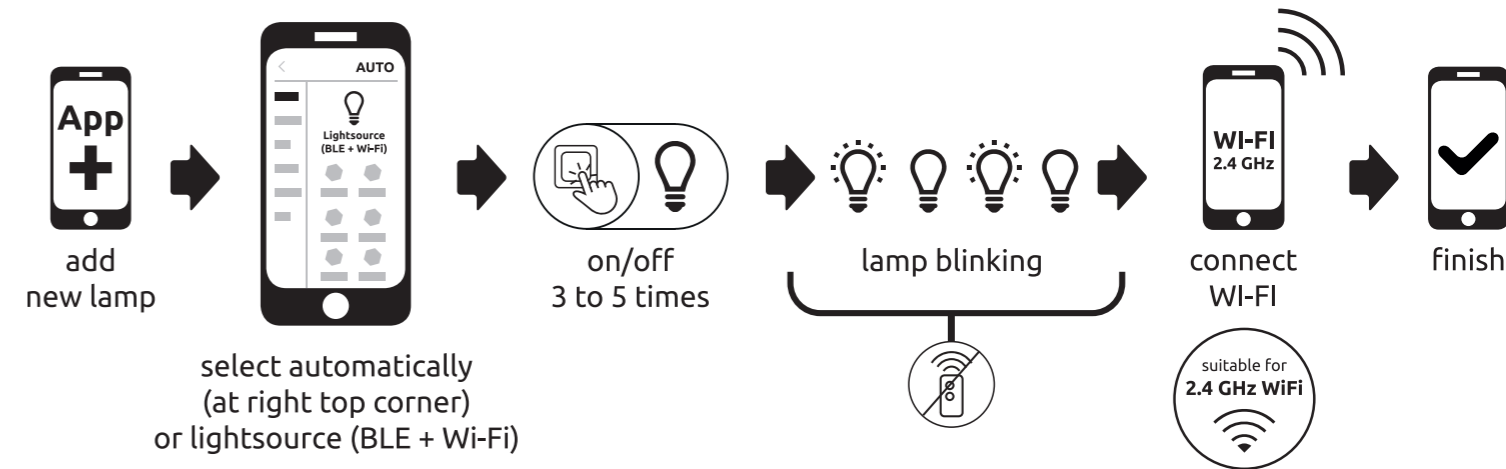

GLOBO Handels GmbH
 Gewerbestr. 3
 A-9184 Sankt Peter, AUSTRIA
www.globo-lighting.com

Lichtquelle / Light Source:

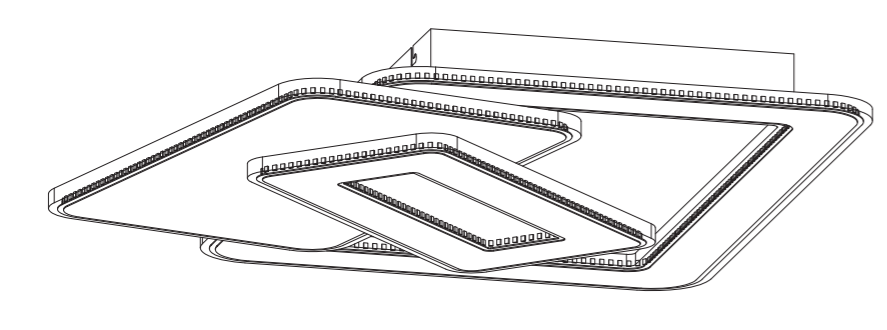



DEU:

Lichtquelle:

Die Lichtquelle ist nicht tauschbar, weil sie konstruktionsbedingt fest mit dem umgebenden Produkt verbunden ist.

Dieses Produkt enthält eine Lichtquelle der Energieeffizienzklasse <E>.

 Betriebsgerät nicht austauschbar.

 Leuchtmittel nicht austauschbar.

GBR:

Light source:

The light source is not interchangeable because it is determined by the surrounding product design.

This product contains a light source of energy efficiency class <E>.

 Non replaceable control gear.

 Non replaceable light source.

BIH & HR:

Izvor svjetla :

Izvor svjetla nije zamjenjiv , jer je konstrukcijski pričvršćen na proizvod .

Ovaj proizvod sadržava izvor svjetlosti klase energetske učinkovitosti <E>.

 Pogonski uređaj se ne može zamjeniti

 LED žarulje nije moguće zamjeniti

BG:

Източник на светлина:

Източникът на светлина не може да се подменя, тъй като поради конструкцията си е трайно фиксиран към заобикалящия го продукт.

Този продукт включва светлинен източник с клас на енергийна ефективност <E>.

 Управляващото устройство не може да се подменя.

 Източникът на светлина не може да се подменя.

CZ:

Zdroj světla:

Světelný zdroj není možné vyměnit, protože je díky své konstrukci pevně spojený s produktem.

Tento výrobek obsahuje světelný zdroj s třídou energetické účinnosti <E>.

 Předřadník není vyměnitelný.

 Světelný zdroj není vyměnitelný.

DK:

Lyskilde:

Lyskilden kan ikke udskiftes, fordi den er fast forbundet med det omgivende produkt.

Dette produkt indeholder en lyskilde i energieffektivitetsklasse < E >.

 Enheden kan ikke udskiftes.

 Lyskilden kan ikke udskiftes.

ET:

Valgusallikas:

Valgusallikas ei ole välja vahetatav, sest ta on tootega ehituslikult kindlalt seotud.

Toode sisaldab energiatõhususe klassi <E> valgusallikat.

 Juhtimisseadis ei ole välja vahetatav.

 Lamp ei ole välja vahetatav.

ES:

Fuente de luz:

La fuente de luz no es sustituable porque está fija en el producto desde la construcción.

Este producto contiene una fuente luminosa de la clase de eficiencia energética <E>.

 Dispositivo de control no reemplazable.

 Bombilla no reemplazable.

FI:

Valonlähde:

Valonlähdettä ei voi vaihtaa uuteen, sillä se on rakenteellisesti yhdistetty ympäröivään tuotteeseen.

Tämä tuote sisältää valonlähteen, jonka energiatehokkuusluokka on <E>.

 Liitäntälaitetta ei voi vaihtaa.

 Valonlähdettä ei voi vaihtaa.

FR:

Source lumineuse:

La source lumineuse n'est pas remplaçable car elle est, de par la construction du produit, liée de façon permanente à celui-ci.

Ce produit contient une source lumineuse de classe d'efficacité énergétique <E>.

 Dispositif de commande non remplaçable.

 Ampoule non remplaçable.

GR:

Φωτεινή πηγή:

Η φωτεινή πηγή δεν μπορεί να αντικατασταθεί, επειδή είναι για κατασκευαστικούς λόγους σταθερά συνδεδεμένη με το προϊόν που την περιβάλλει.

Το προϊόν αυτό περιέχει φωτεινή πηγή της τάξης ενεργειακής απόδοσης <E>.

 Η διάταξη λειτουργίας δεν μπορεί να αντικατασταθεί.

 Ο λαμπτήρας δεν μπορεί να αντικατασταθεί.

HU:

Fényforrás:

A fényforrás nem cserélhető, mert felépítése miatt szilárdan csatlakozik a termékhez

Ez a termék egy <E> energiahatékonysági osztályú fényforrást tartalmaz.

 Az előtét nem cserélhető.

 A fényforrás nem cserélhető

Isländisch/IS:

Ljósgjafi:

Ljósgjafinn er ekki útskiptanlegur vegna þess að hann er háður umliggjandi hönnun vörunnar.

Varan inniheldur ljósgjafa í orkuflokki <E>.

 Ekki útskiptanlegur stýribúnaður.

 Ekki útskiptanlegur ljósgjafi.

IT:

Sorgente luminosa:

La sorgente luminosa non è intercambiabile perché è saldamente collegata al prodotto per via del suo design.

Questo prodotto contiene una sorgente luminosa di classe di efficienza energetica <E>.

 Sostituzione dell'alimentatore da parte di un professionista.

 Alimentatore non sostituibile.

LV:

Gaismas avots:

Gaismas avotu nevar nomainīt, jo tas konstrukcijā ir cieši savienots ar izstrādājuma apkārtējo daļu.

Šis ražojums satur gaismas avotu, kura energoefektivitātes klase ir <E>.

 Vadības ierīci nevar nomainīt.

 Apgaismes līdzekli nevar nomainīt.

LT:

Šviesos šaltinis:

Šis šviesos šaltinis yra nekeičiamas, nes jis prijungtas prie gaminio pagal jo konstrukciją.

Šiame gaminyje yra šviesos šaltinis, kurio energijos vartojimo efektyvumo klasė <E>.

 Valdymo įtaisas yra nekeičiamas.

 Šviesos šaltinis yra nekeičiamas.

NL:

Lichtbron:

De lichtbron kan niet worden vervangen, omdat deze vanwege de constructie vast met het product eromheen verbonden is.

Dit product bevat een lichtbron van energie-efficiëntieklasse <E>.

 Apparaat kan niet worden vervangen.

 Verlichting kan niet worden vervangen.

Norwegisch/Norwegian / NO:

Lyskilde:

Lyskilden kan ikke byttes fordi den sitter fast i produktet.

Dette produktet inneholder en lyskilde i energiklasse <E>.

 Driftsapparatet kan ikke byttes ut.

 Lyskilden kan ikke byttes ut.

PL:

Źródło światła:

Źródła światła nie można wymienić, ponieważ jest zintegrowane z produktem ze względu na swoją konstrukcję.

Ten produkt zawiera źródło światła o klasie efektywności energetycznej <E>.

 Osprzętu sterującego nie można wymienić.

 Źródła światła nie można wymienić.

PT:

Fonte de Luz:

A fonte de luz não é substituível porque devido às suas características construtivas está fixada de forma permanente ao produto circundante.

Este produto contém uma fonte de luz da classe de eficiência energética <E>.

 Dispositivo de comando não substituível.

 Lâmpada não substituível.

RO:

Sursa de lumina:

Sursa de lumina nu este inlocuibilă ea fiind parte constructivă a produsului

Acest produs conține o sursă de lumină cu clasa de eficiență energetică <E>.

 Unitatea de control nu poate fi schimbata

 Sursa de lumina nu poate fi schimbata

RUS:

Источник света:

Источник света не является взаимозаменяемым, поскольку это определяется конструкцией смежного продукта.

Данный продукт содержит источник света класса энергоэффективности <E>.

 Незаменяемый регулировочный механизм

 Незаменяемый источник света.

SRB:

Izvor svetlosti:

Izvor svetlosti nije zamenljiv, jer je zbog svog dizajna čvrsto povezan sa proizvodom koji ga opkrružuje.

Ovaj proizvod sadrži izvor svetlosti klase energetske efikasnosti <E>.

 Upravljački uređaj nije zamenljiv.

 Izvor svetlosti se ne može zameniti.

SK:

Zdroj svetla:

Svetelný zdroj nie je možné vymeniť, pretože je vďaka svojej konštrukcii pevne spojený s produktom.

Tento výrobok obsahuje svetelný zdroj triedy energetickej účinnosti <E>.

 Predradník nie je vymeniteľný.

 Svetelný zdroj nie je vymeniteľný.

SI:

Izvor svetlobe:

Vir svetlobe ni zamenljiv, ker je določen z zasnovo izdelka v okolici.

Ta izdelek vsebuje svetlobni vir razreda energijske učinkovitosti <E>.

 Nezamenljiv krmilnik.

 Nezamenljiv vir svetlobe.

SE:

Ljuskälla:

Ljuskällan är inte utbytbar, eftersom den på grund av konstruktionen är fast integrerad i den omgivande produkten.

Denna produkt innehåller en ljuskälla med energieffektivitetsklass <E>.

 Driftdonet kan inte bytas ut.

 Ljuskällan är inte utbytbar.

TR:

İşık kaynağı:

Konstrüksiyon gereği çevreleyen ürün ile sabit bir şekilde bağlı olduđu için ışık kaynağı deđiştirilemez.

Bu ürün, <E>enerji sınıfından bir ışık kaynađına sahiptir.

 İşletme cihazı deđiştirilemez.

 Aydınlatma malzemesi deđiştirilemez.

UK:

Джерелосвітла:

Джерелосвітланеможнаобміняти, оскількивиномоцінопов'язанезнавколишнімвиробомзавдякисвоїйконструкції.

Цей виріб містить джерело світла класу енергоефективності <E>.

 Редуктор не є змінним.

 Цибулининезаємозамінні.