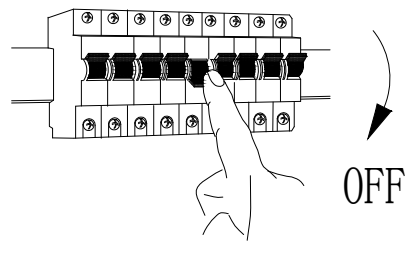
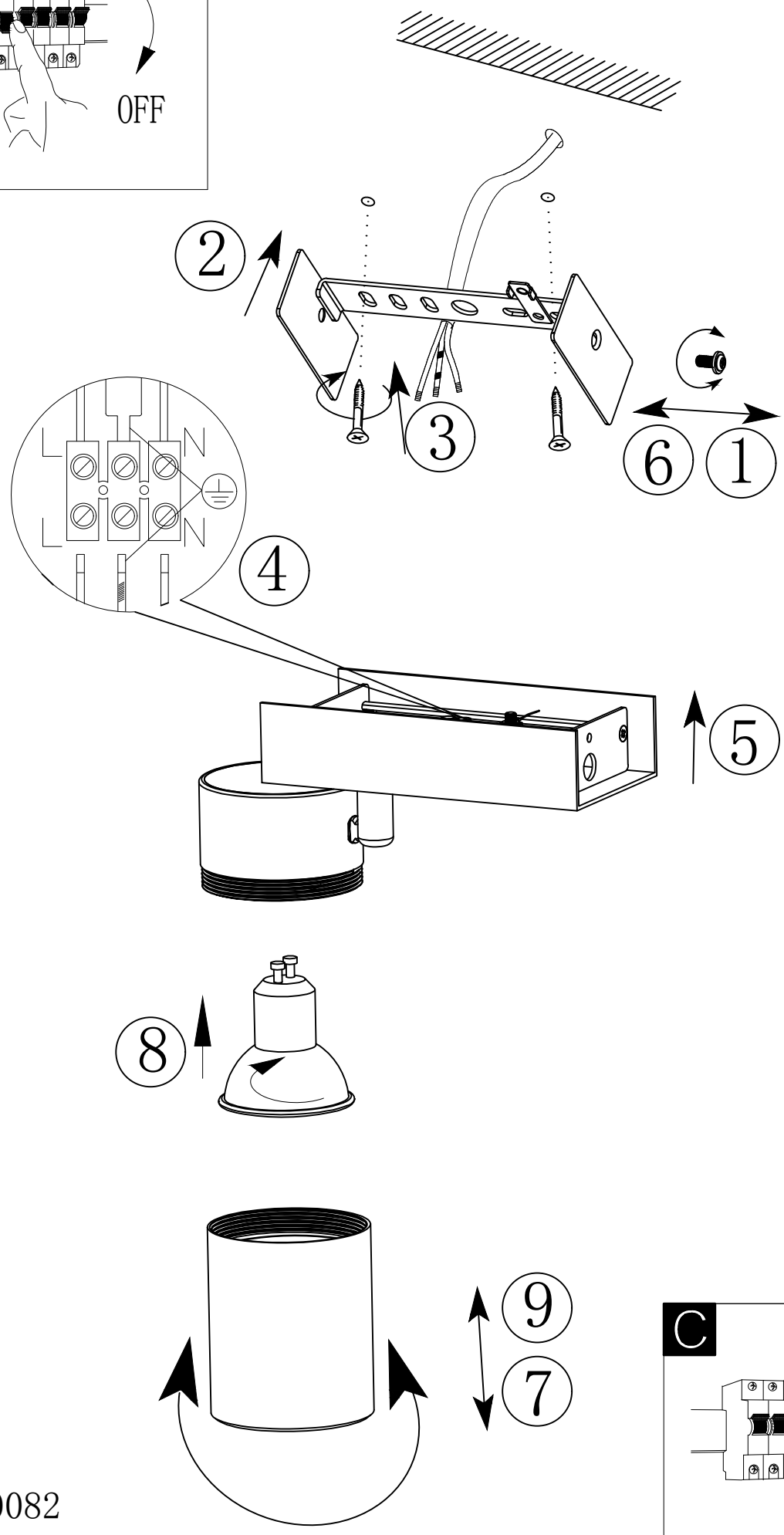
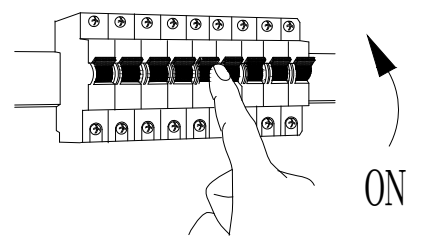

**A****B****C**

BLA390082  
www.eglo.com