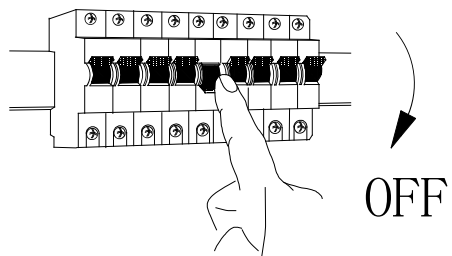
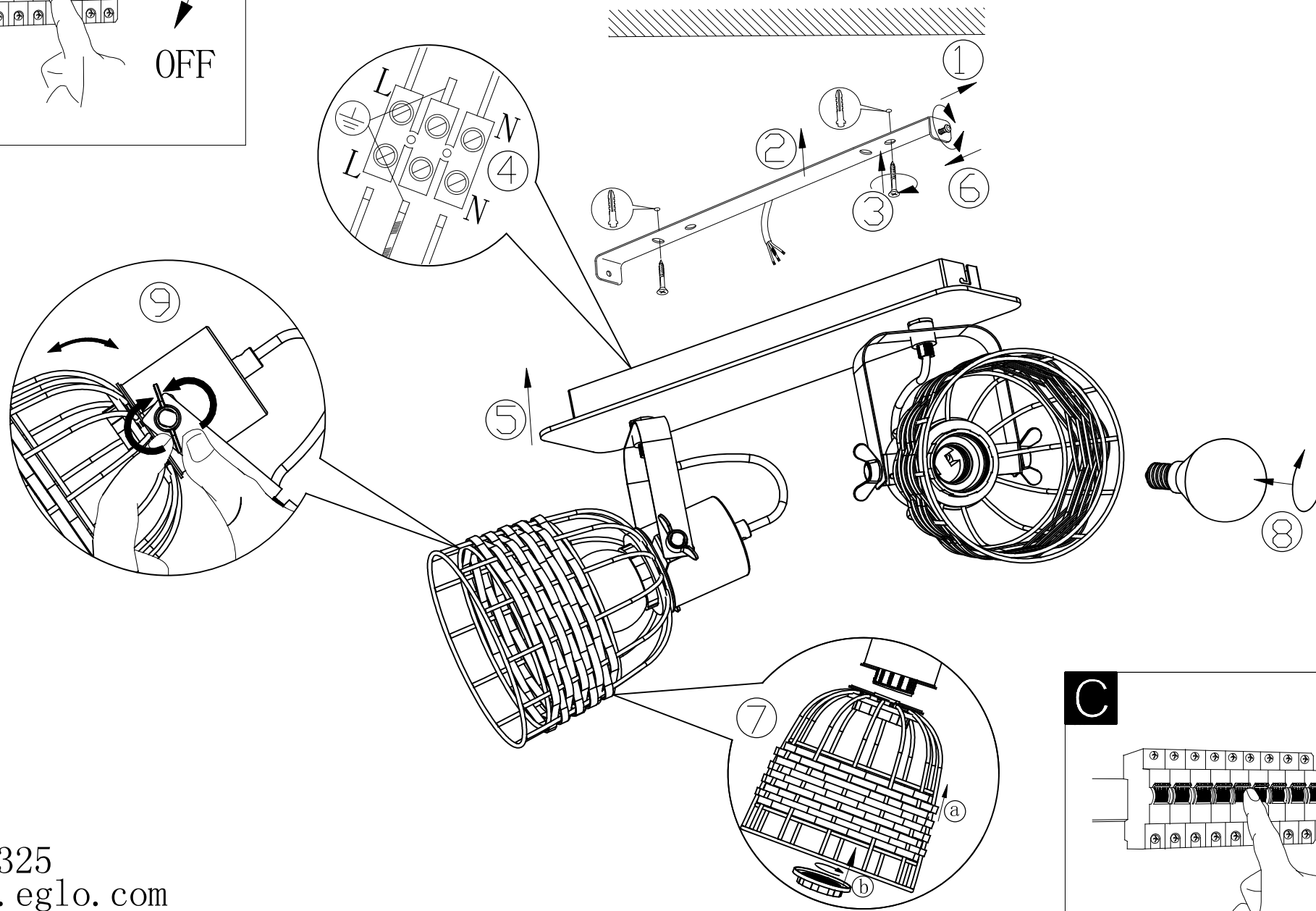
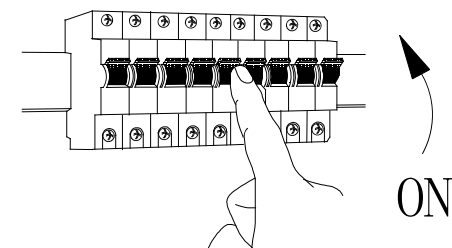

A**B****C**

B43325
www.eglo.com