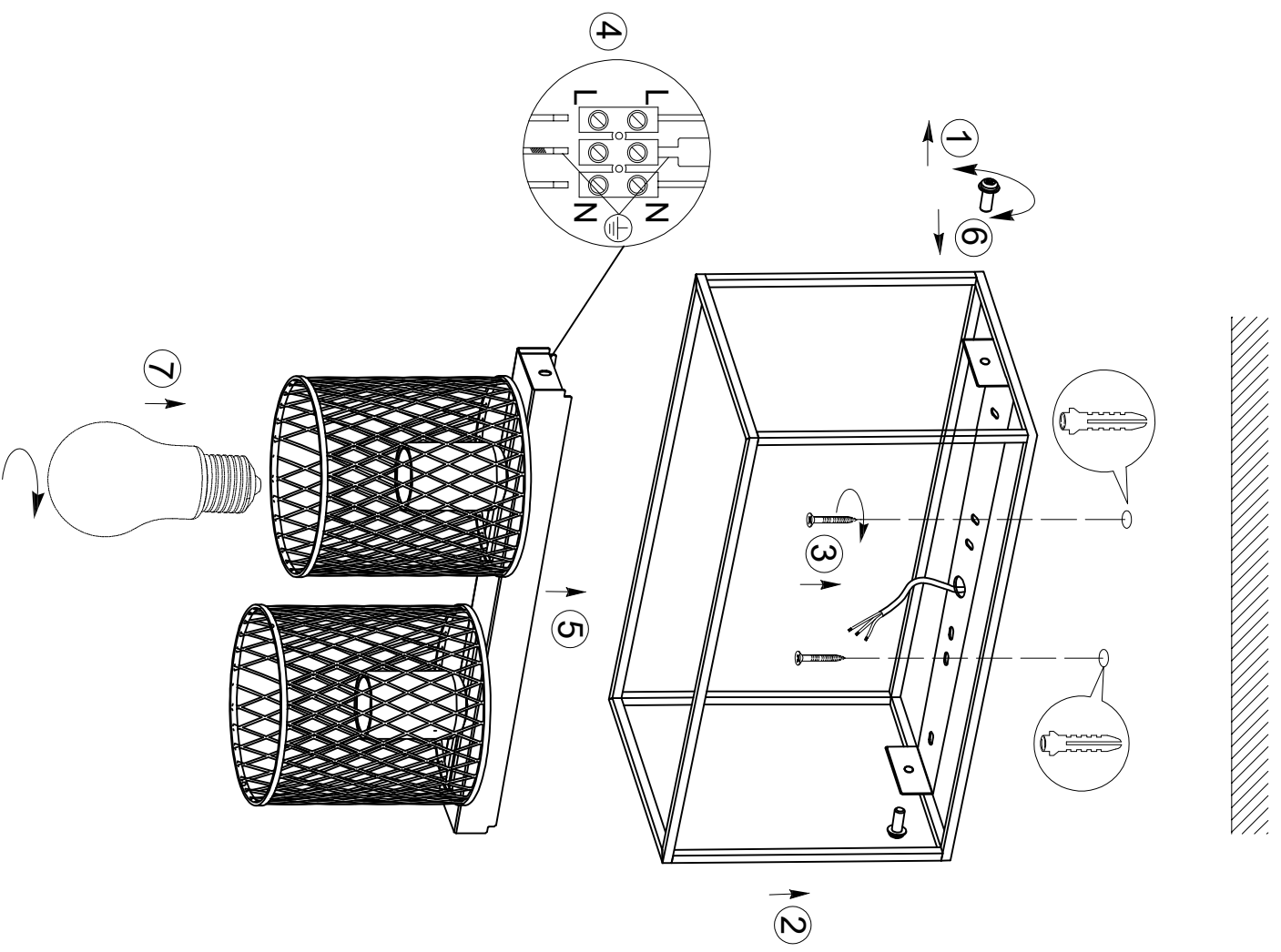
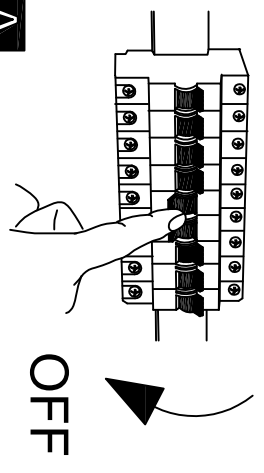
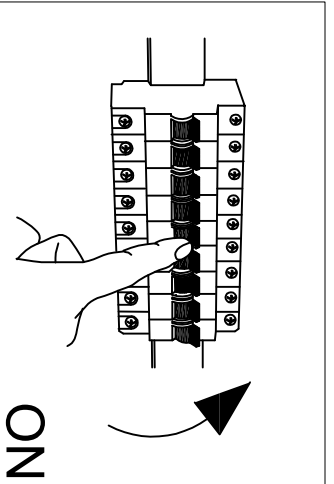

B**A****C**

B43772

www.eglo.com